

# HIGH DREAM MULTIHEAD WEIGHER



HDM® 海川智能

Stock Code: 300720

GUANGDONG HIGH DREAM INTELLECTUALIZED MACHINERY CO.,LTD

Address: No.3 Longzhan Road, Huanglong, Beijiao Town, Shunde Foshan City, Guangdong, China

Tel: +86-757-22393573 Fax: +86-757-22393570 Website: [www.highdream.net](http://www.highdream.net)

Email: [info@highdream.net](mailto:info@highdream.net)

Stock Code: 300720

# Company Introduction

Guangdong High Dream Intellectualized Machinery Co., Ltd is a famous manufacturer of automatic weighing and metering devices, we provide customers with systematic solutions from product design, R&D, manufacturing, marketing, installation commissioning, technical training and after-sales service. High Dream has developed a variety of international level computerized multihead weigher, metal detector, check weigher, loss-in-weight feeder etc, which facilitate the intergration of multihead weigher and various packaging systems, from accurate feeding, weighing, bag filling, fast packaging, weight checking to metal detecting.

Based on 13 years' fast developing, Highdream IPO successfully and listed on China stock market from November 2017(Stock code: 300720). High Dream has grown to absolute leading manufacturer in the industry, own more than 480 full-time employees, 55 domestic and foreign patents, company area up to 72,300m<sup>2</sup>, widespread users from more than 120 countries and areas around the world.

"Integrity, Quality, Innovation" is an everlasting business philosophy that High Dream adheres to. While comprehensively improving the industrial services of our products, we will endeavor to become an international professional supplier of weighing, packaging and metering system by virtue of international cooperation, innovation concept and strong management capability.



Highdream New Headquarter

# Certification



ISO9001:2015 Certification



CE Certification



Scale-maker Certification

# Company Strength



**3** Major production bases

**480** Well-trained employees

**73600** M<sup>2</sup> Company space in total

Guangdong Highdream Intellectualized Machinery Co.,Ltd

Establish date: 2004

Company area: 50,000 M<sup>2</sup>



Hunan Sunflower Software Development Co.,Ltd.

Establish date: 2011

Company area: 2,300 M<sup>2</sup>



Accubal Intellectualized machinery Co.,Ltd

Establish date: 2013

Company area: 20,000 M<sup>2</sup>



KW.TW Machinery GmbH:

Establish date: 2022

Company area: 1300 M<sup>2</sup>

Exhibitions



Customer Cases



## Automatic Weighing, Packaging, Checking & Detecting

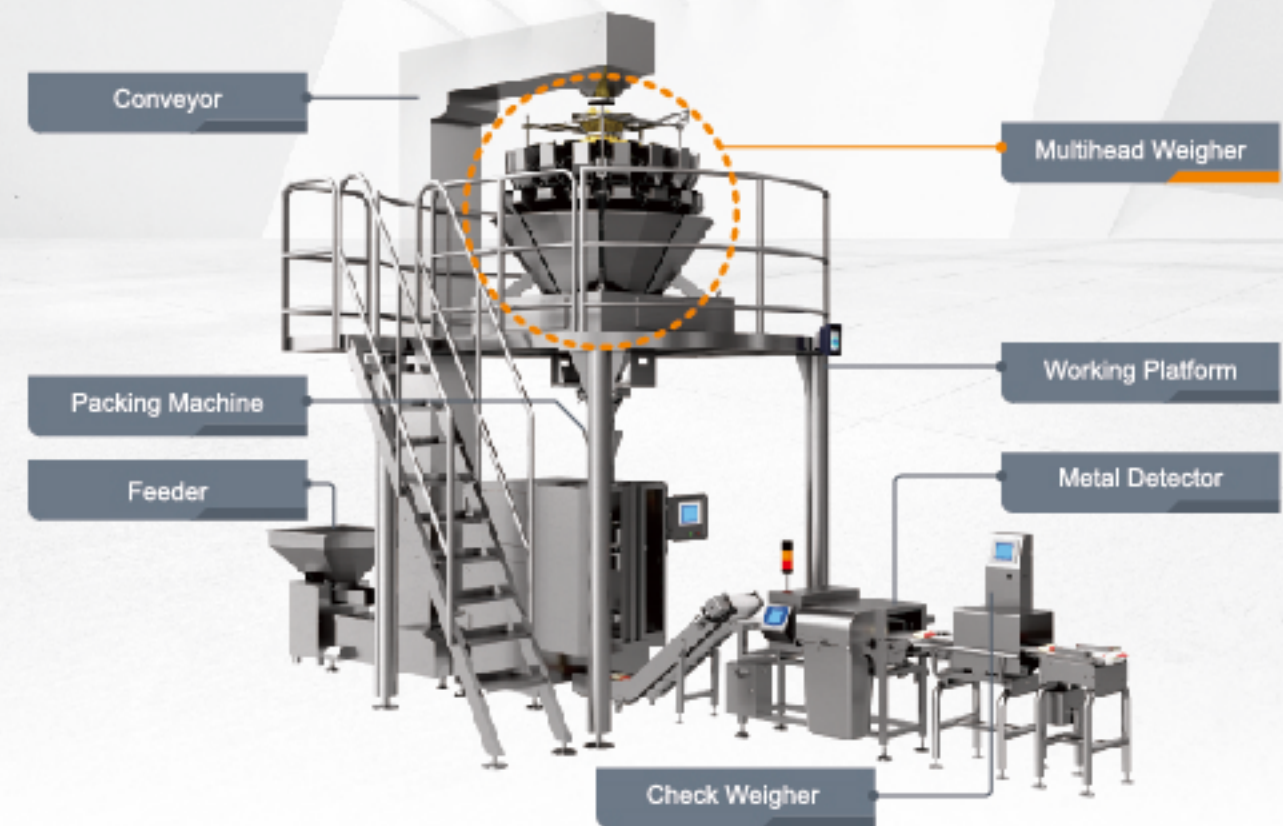

## Working Method

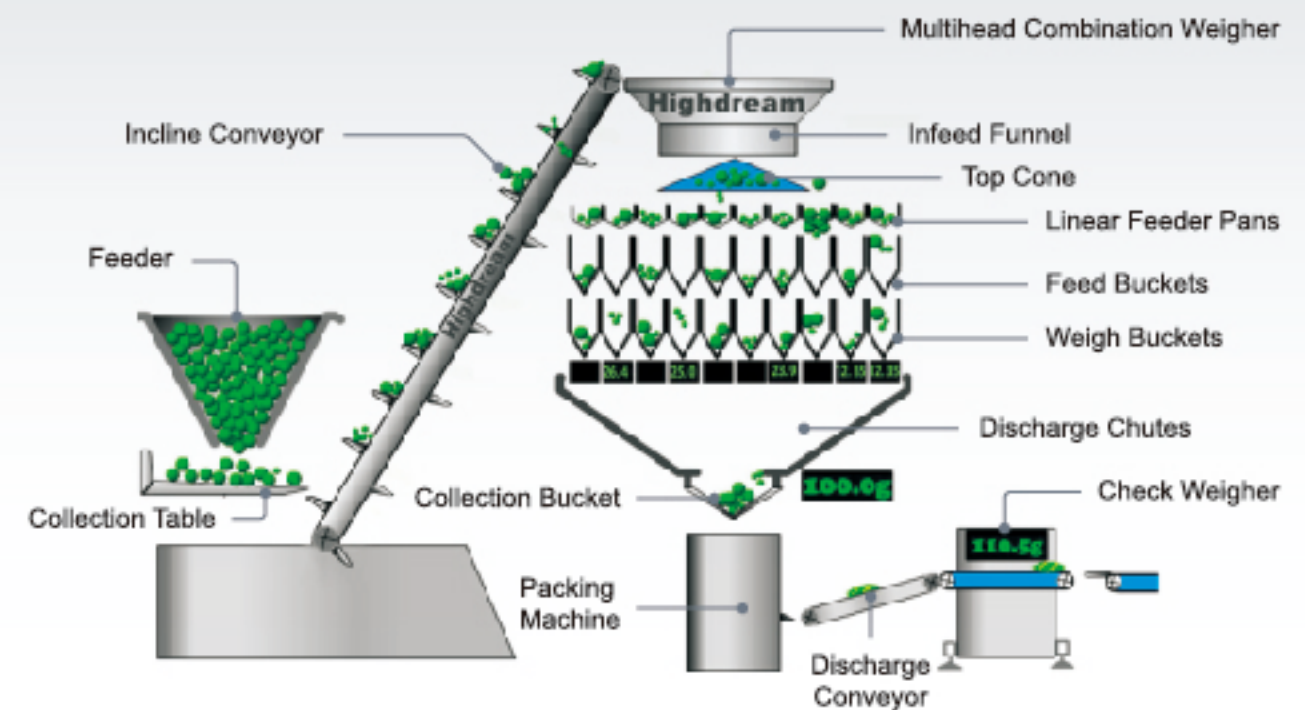

# MULTIHEAD WEIGHER PACKAGING SYSTEMS

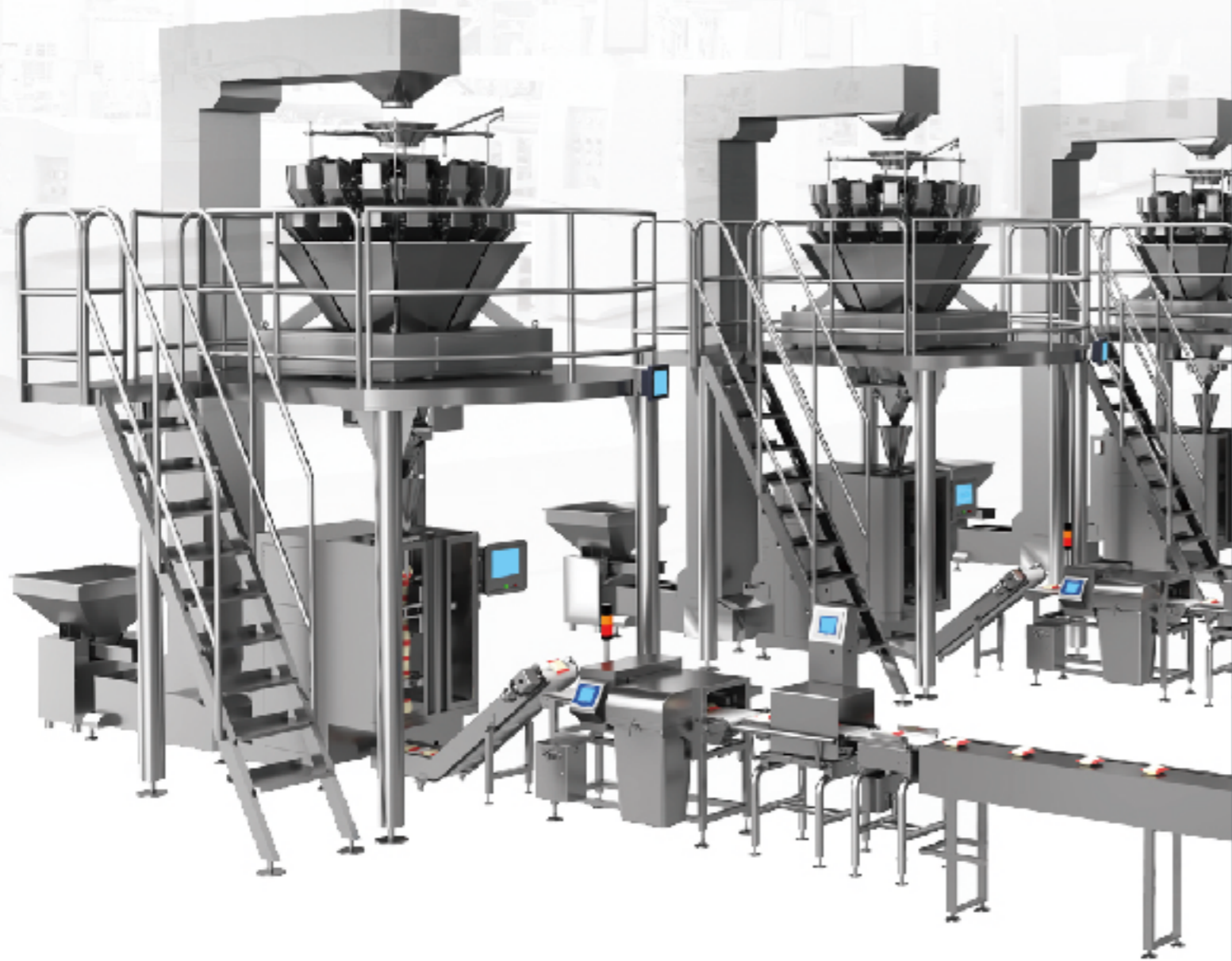

## Contents

4.0 Generation Basic Weigher	01
4.0 Generation Plus Weigher	03
4.0 Generation Atlantic Plus Weigher	05
Compact Weigher	07
Large Volume Weigher	09
Memory Hopper Weigher	11
Anti-Sticky Weigher	15
Screw Feeder Weigher	17
Stick-Shape Weigher	18
Potato Weigher	19
Anti-Fragile Weigher	20
Super Precision Micro Weigher	21
Manual Weigher	22
Anti-Dust Weigher	23
Options & Modifications	24

# 4.0 GENERATION **BASIC** WEIGHER



New upgraded model



## Main Features

- Highdream's best standard weigher in history.
- 4.0 generation modular control system.
- Robust design and construction.
- More than 30 improvements.
- Full stainless steel machine.

AC-6B10-4A-24 (10 Heads)



## Specifications

Item	4.0G Basic 10-Head Multihead Weigher	4.0G Basic 14-Head Multihead Weigher	4.0G Basic 20-Head Multihead Weigher
Model	AC-6B10-4A-24 AC-6B10-4A-30	AC-6B14-4A-24 AC-6B14-4A-30	AC-6B20-4A-24 AC-6B20-4A-30
Generation	4.0G Basic	4.0G Basic	4.0G Basic
Weighing Range	15g-1000g	15g-1000g	15g-1000g
Accuracy	±0.5-2g	±0.5-2g	±0.5-2g
Max.speed	70WPM	110WPM	60*2WPM
Power Supply	220V,50HZ,2.0KW	220V,50HZ,2.6KW	220V,50HZ,3.5KW
Hopper Volume	1.6L/3L		
Monitor	10.4 inches color touch screen		
Dimension(mm)	1054×1075×1374	1202×1210×1438	1440×1440×1550
Optional	Independent linear feeder pan/V shape linear feeder pan / skirt on linear feeder pans / Cylinder gate on linear feeder pans / collection bucket . Rotary top cone/Diameter and angle of top cone/316 Stainless steel / Linear feeder pan angle/ Cross baffle for outfeed funnel/ Teflon coating / Collating chute angle		

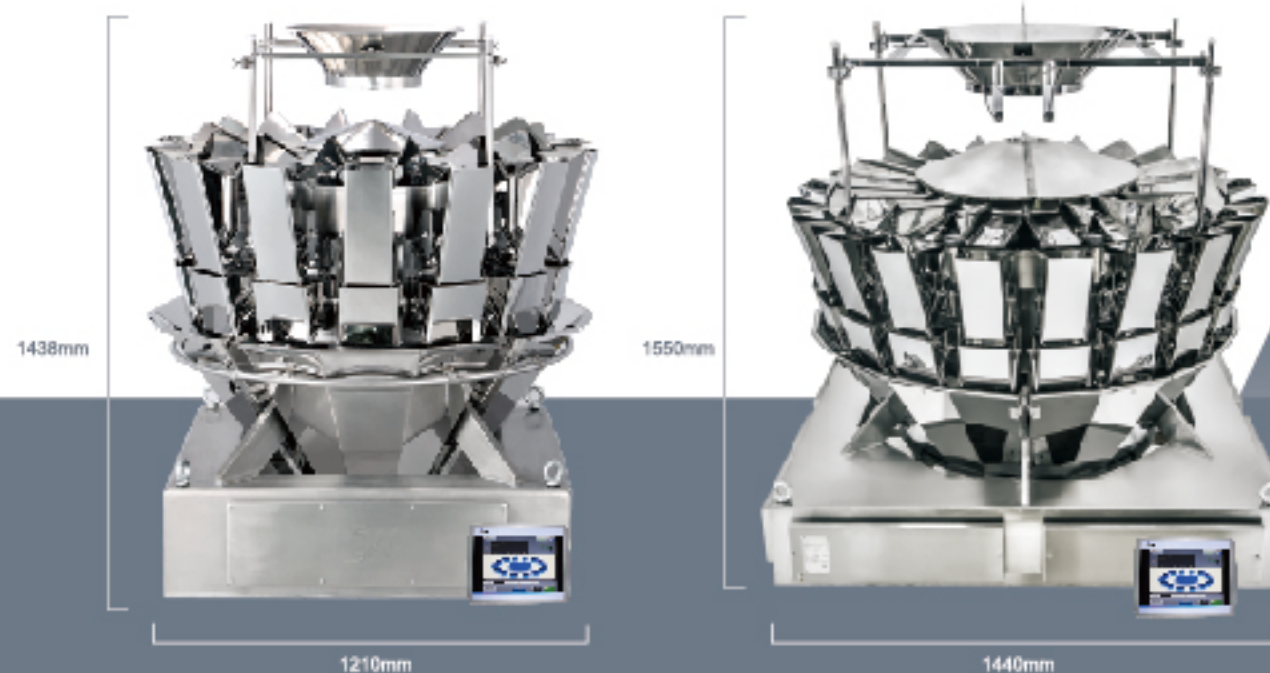

AC-6B14-4A -24 (14 Heads)

AC-6B20-4A-24 (20 Heads)

# 4.0 GENERATION *PLUS* WEIGHER

High speed version



## Main Features

- New 4.0 generation PLUS advanced control system.
- World-class multihead weighers combine fast and accurate weighing.
- Robust design and construction with higher production standards.
- 3D menu monitor with smarter functions achieve easier and simpler operation.
- Software and mechanic improvements achieve top performance in the industry.



AC-6B10-4A-15 (10 Heads)



## CANBus architecture with modular actuator control system

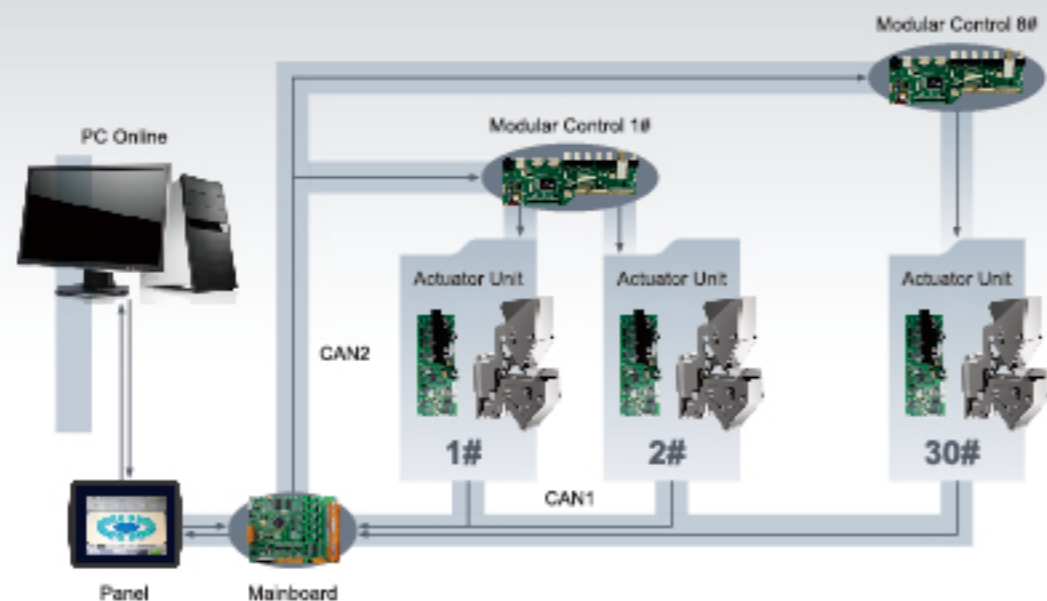

## Specifications

Item	4.0G Plus 10 Heads Weigher	4.0G Plus 14 Heads Weigher
Model	AC-6B10-4A-15 AC-6B10-4A-30VF	AC-6B14-4A-15 AC-6B14-4A-30VF
Generation	4.0G Plus	4.0G Plus
Weighing Range	15g-1000g	15g-1000g
Accuracy	±0.5-2g	±0.5-2g
Max.speed	80WPM	130WPM
Power Supply	220V,50/60HZ,1.5kW	220V,50/60HZ,2kW
Hopper Volume	1.6L/3L	1.6L/3L
Monitor	10.4 inches color touch screen	10.4 inches color touch screen
Dimension(mm)	1500*1120*1400	1600*1210*1550
Optional	Independent linear feeder pan/ V shape linear feeder pan / Buffer plastic board/ Skirt on linear feeder pan / Cylinder gate on linear feeder pan/ Pressure valve/ Heater/ Foot paddle switch.	

AC-6B14-4A-15 (14 Heads )

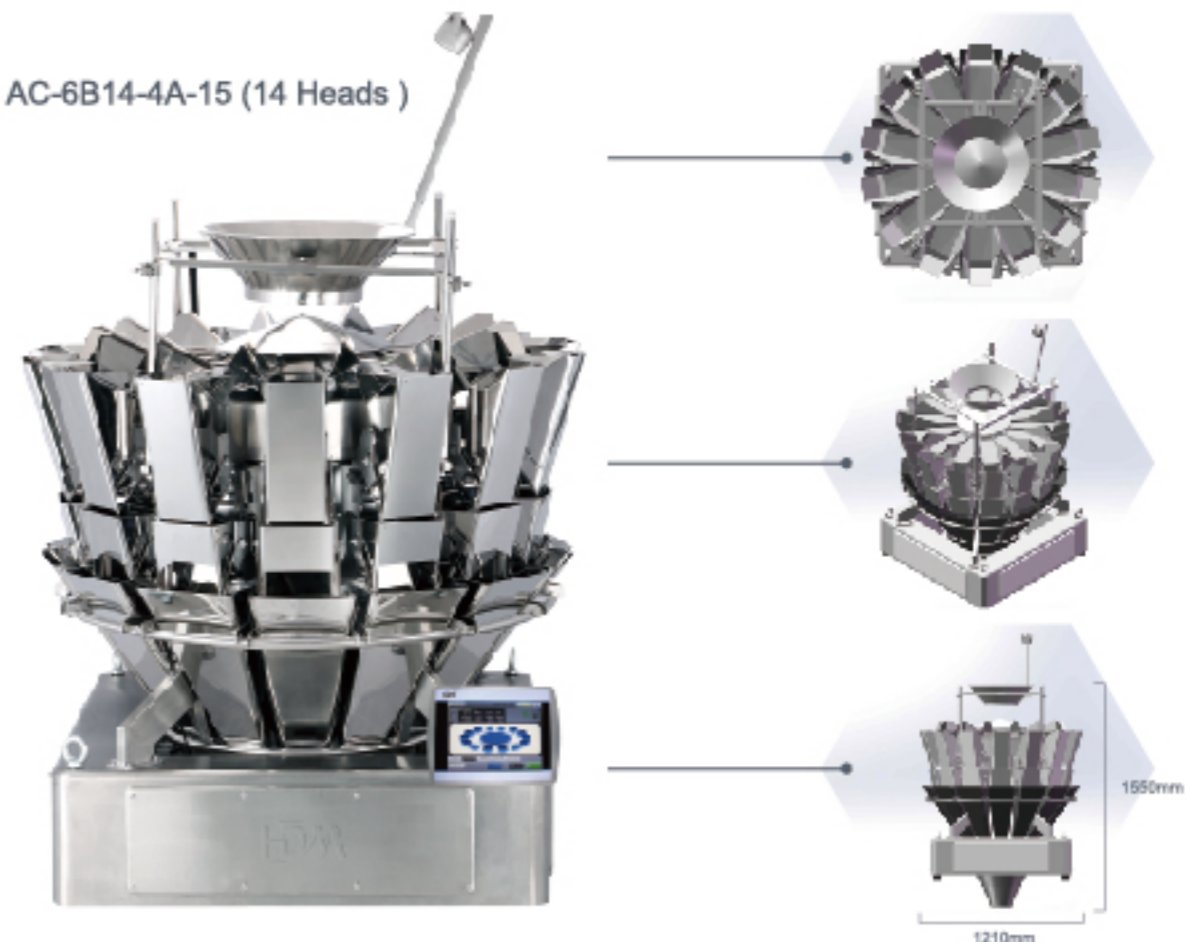

# 4.0 GENERATION ATLANTIC **PLUS** WEIGHER

The 4.0 Generation ATLANTIC plus model multihead weigher stands for Highdream's top level technology and production engineering.

ATLANTIC weigher is a multipurpose machine ideal for packaging lines that process wet, fresh, frozen food products, and dry items etc.



Top level weigher



## Main Features

- One of the highest performance multihead weigher in the world.
- World-class machinery combine with fast and accurate weighing.
- Industry 4.0 generation advanced control system.
- 3D menu monitor with smarter functions achieve easier and simpler operation.
- Multipurpose machine ideal for most of weighing applications.

## Specifications

Item	Atlantic plus 10 heads Weigher	Atlantic plus 14 heads Weigher
Model	AC-6B10-4A-21F	AC-6B14-4A-21F
Generation	4.0G plus	4.0G plus
Weighing Range	15g-1000g	15g-1000g
Accuracy	±0.5-2g	±0.5-2g
Max.speed	90WPM	150WPM
Power Supply	220V,50/60Hz,2.0kW	220V,50/60Hz,2.5kW
Hopper Volume	2.5L(Springfree)	2.5L(Springfree)
Monitor	10.4 inches color touch screen	10.4 inches color touch screen
Dimension(mm)	1293×1234×1656	1374×1343×1681
Optional	Rotary top cone/ Independent linear feeder pan/ V shape linear feeder pan / Buffer plastic board/ Skirt on linear feeder pan / Cylinder gate on linear feeder pan/ Pressure valve/ Heater/ Foot paddle switch.	

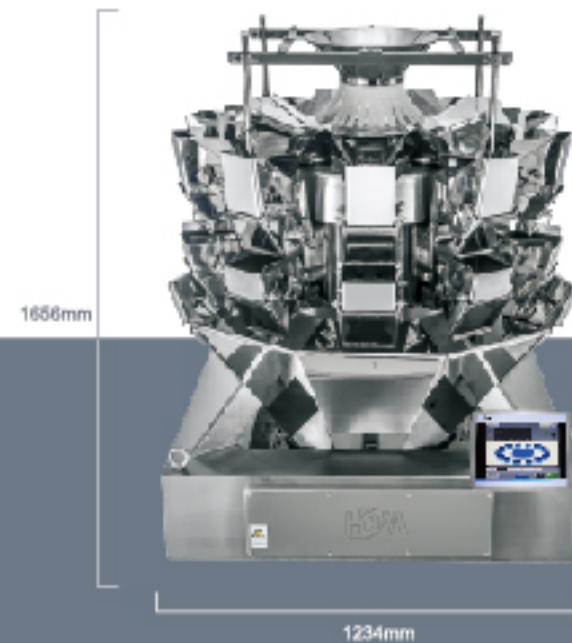

AC-6B10-4A-21 (10 heads)

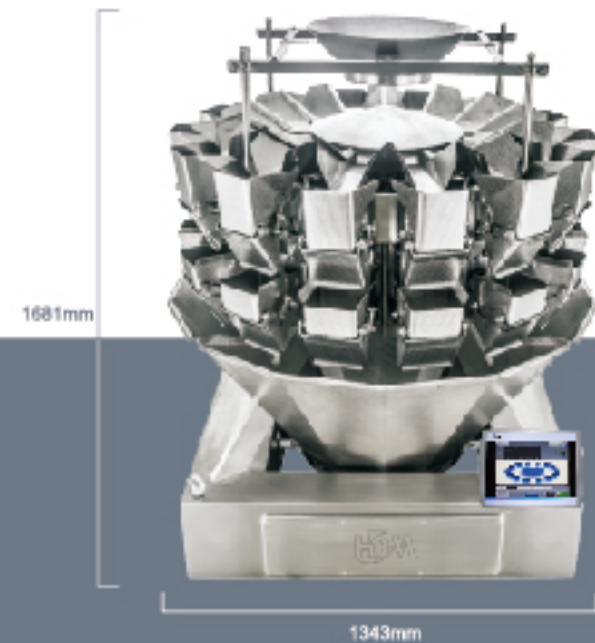

AC-6B14-4A-21 (14 heads)

# COMPACT WEIGHER

## Application

Herb granule/ seed/ tea leaves/ small dry products/ Food additives/seasoning/medicine and capsules etc.

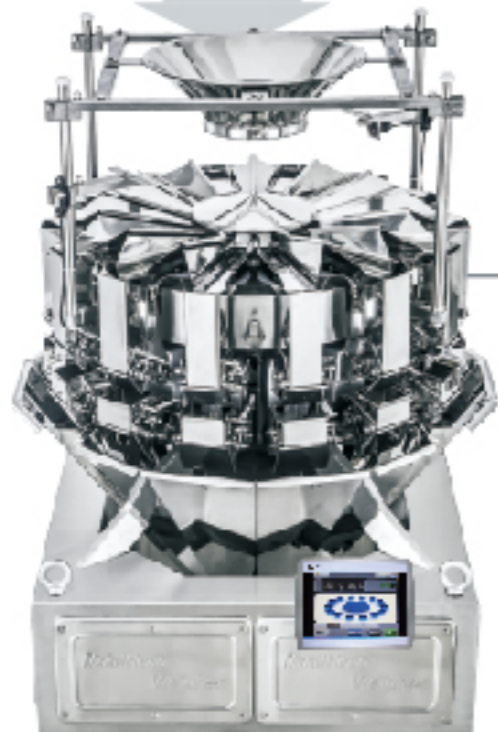

**AC-6B14-4A-12 (14 Heads)**

*Compact & Precise*



### Main Features

- Compact weigher is capable of handling low target weights at ideal speed and with unsurpassed accuracy.
- It can do target weights from 2g to 300g ,by 10 heads and 14 heads combination weigher , accuracy from 0.2g to 1g ,ideal for handling small granual products at strict accuracy.

## Specifications

Item	High Precision Compact 10 heads Weigher	High Precision Compact 14 heads Weigher
Model	AC-6B10-4A-13	AC-6B14-4A-12
Generation	4.0G Basic	4.0G Basic
Weighing Range	2g-300g	2g-300g
Accuracy	±0.1-1g	±0.1-1g
Max.speed	80WPM	130WPM
Power Supply	220V,60HZ,1.5kW	220V,60HZ,2kW
Hopper Volume	0.8L(Dimple/Plain)	0.5L(Dimple/Plain)
Monitor	10.4 inches color touch screen	10.4 inches color touch screen
Dimension(mm)	750*750*1119	800*800*1207
Optional	Indeed tower/ Central Loadcell weighing/ Independent linear feeder pan/Collection bucket.	

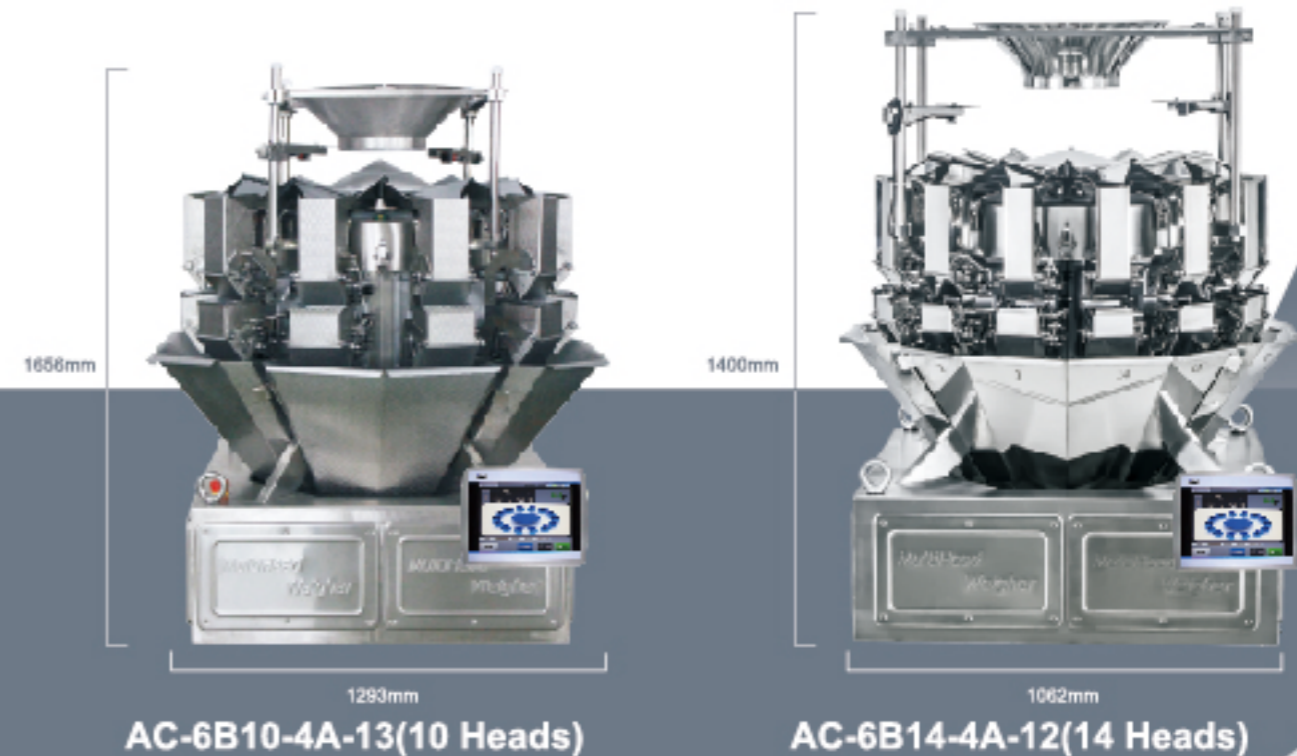

**AC-6B10-4A-13(10 Heads)**

**AC-6B14-4A-12(14 Heads)**



# LARGE VOLUME WEIGHER

## Application



Larger Volume 5.5/7.5L Hoppers



## Main Features

- Special big machine designed for big size products.
- Bigger hopper volume , stronger vibrator and larger opening doors.
- Adjustable rotating topcone to dispense leaf products evenly.
- New 4.0 generation software makes control easier and faster.
- More models available including 10 heads, 14 heads and 16 heads.
- Biggest volume 7.5 liters hopper for wider applications.

AC-6B16-4A-27F (16 Heads)

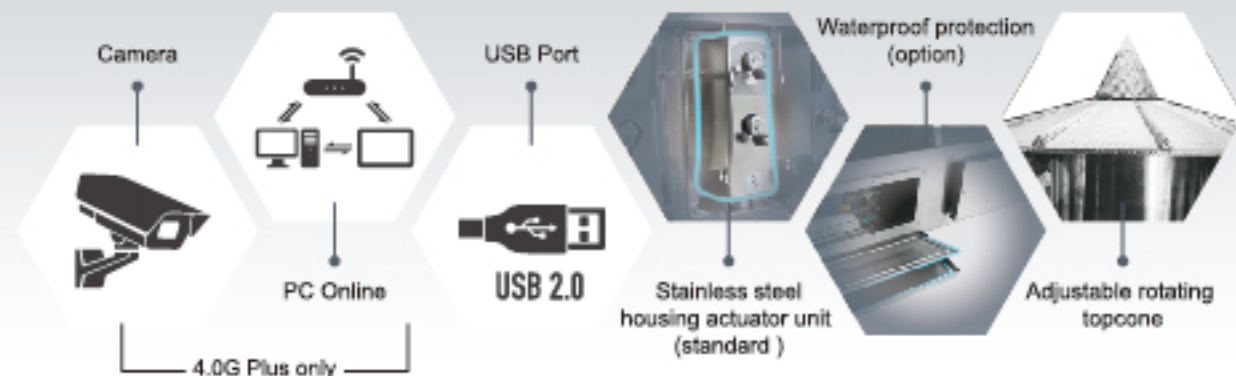

## Specifications

Item	Large Volume hopper 10 head Multihead Weigher	Large Volume hopper 14 head Multihead Weigher	Large Volume hopper 16 head Multihead Weigher
Model	AC-6B10-4A-31F AC-6B10-4A-27F	AC-6B14-4A-31F AC-6B14-4A-27F	AC-6B16-4A-31F AC-6B16-4A-27F
Generation	4.0G Basic/Plus	4.0G Basic/Plus	4.0G Plus
Weighing Range	25g-5000g	25g-5000g	25g-5000g
Accuracy	±1-8g	±1-8g	±1-8g
Max.speed	60WPM	80WPM	100WPM
Power Supply	220V,50HZ,3.0KW	220V,50HZ,3.5KW	220V,50HZ,3.5KW
Hopper Volume	5.5L , 7.5L	5.5L , 7.5L	5.5L , 7.5L
Monitor	10.4 inches color touch screen		
Dimension(mm)	1904×1838×2205	2031×2031×2178	2160×2160×2607
Optional	Skirt on linear feeder pan / Cylinder gate on linear feeder pan / Pressure valve / Heater Rotary top cone/ Plate hopper/ 316 Stainless steel/Linear feeder pan angle/Cross baffle in collating funnel/Diameter and angle of collating funnel / Teflon coating/ Collating chute angle.		



AC-6B10-4A-27F(10 Heads)



AC-6B14-4A-27F(14 Heads)

# MEMORY HOPPER WEIGHER

Practical high speed solution



## Main Features

- High speed for bigger volume product, 150 weighs/min working with continuous VFFS.
- Complete stainless steel housing actuator for hygiene request.
- New memory hopper technology applied to achieve higher speed and accuracy.
- New type 2 liters single door hopper is simple and stable to work.

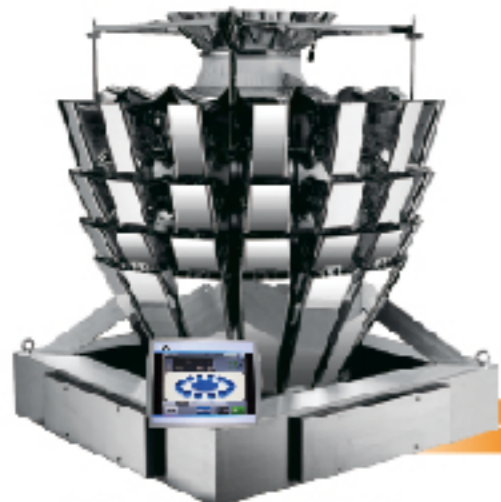

### AC-6B16-4A-26

16-head weigher with 2 liters single door hopper



### AC-6B16-4A-21 (springfree)

16-head weigher with 2.5 liters double doors hopper

3 layers of hoppers	Hanging actuator unit	Stainless steel housing
Camera	PC Connection	USB Port
Complete stainless steel housing	Springfree hoppers	Hygiene construction
3 layers hoppers	On-line camera	High speed two ways TH

## Specifications

Item	High speed 16-head single door with memory hopper	High speed 16-head double doors with memory hopper
Model	AC-6B16-4A-26	AC-6B16-4A-21
Generation	4.0G Plus	4.0G Plus
Weighing Range	15g~1000g	15g~1000g
Max.speed	160WPM or 2x80WPM	160WPM or 2x80WPM
Power Supply	220V,50/60HZ,3.5kW	220V,50/60HZ,3.5kW
Hopper Volume	2 Liters with single door	2.5 Liters with springfree double doors
Monitor	10.4 inches color touch screen	
Dimension(mm)	1600×1600×1597	

Speed 150 weighs/min (16 Heads)

Speed 200 weighs/min (18 Heads)

Working with one high speed continuous bagger

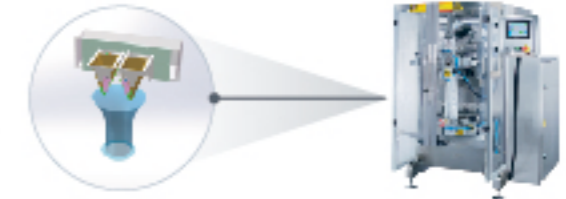

Speed 75x2 weighs/min (16 Heads)

Speed 90x2 weighs/min (18 Heads)

Working with twin bagger

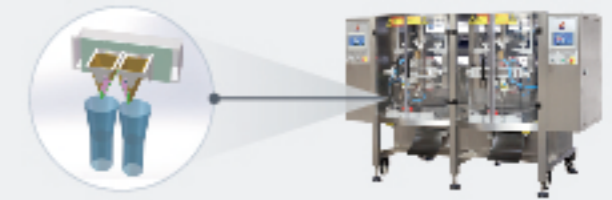

Speed 60x4 weighs/min (24 Heads)

Working with multilane packaging machine



Multiple discharges (2 to 5 points by 16-30 Heads)

To thermoforming machine, tray and bottle machines etc.



# MEMORY HOPPER WEIGHER

## Memory bucket working principle

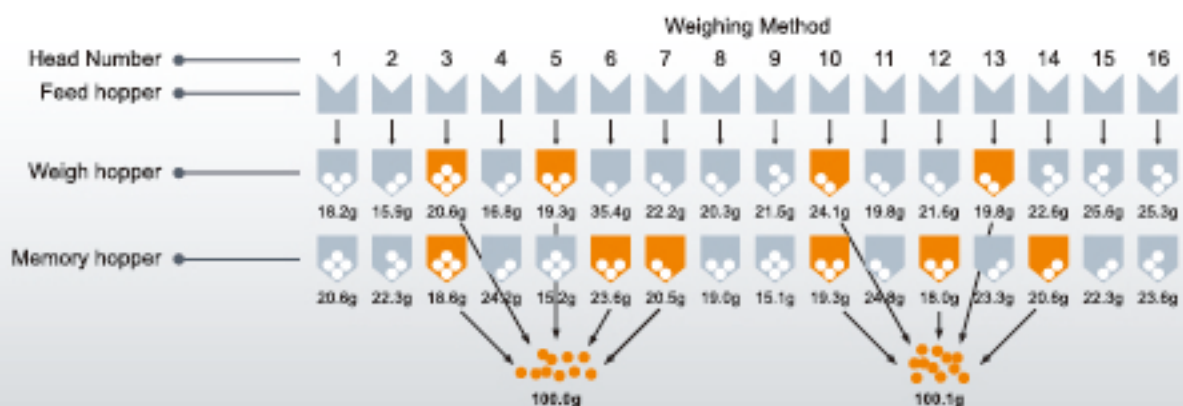

Blending and high speed weigher



## Main Features

- Three layers of hoppers: feed hopper, weigh hopper and memory hopper.
- Achieve more combinations, higher accuracy and higher speed.
- Maximum speed upto 200 weighs/min with one continuous vertical packing machine, twin bagger or multiline packing machine.
- Multiple discharge can working with twin or multiline packing machine.
- Blending two to five different products, compensation function achieve best total weight.

## AC-6B18-4C-19 (18 Heads)

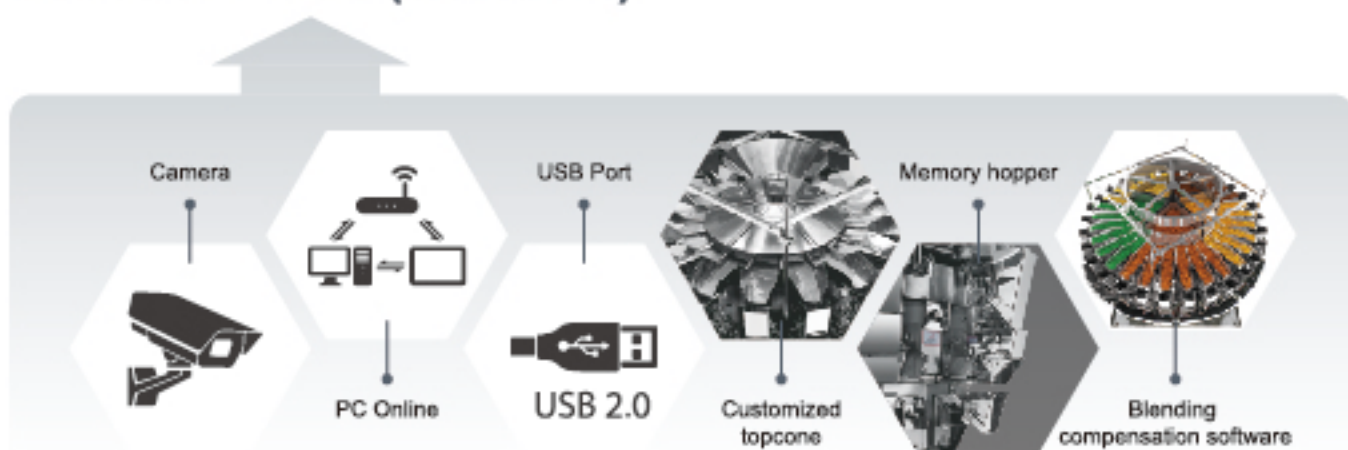

## Specifications

Item	High Speed 18-Head Weigher With Memory Hopper	24 Heads Blending Weigher With Memory Hopper	30 Heads Blending Weigher With Memory Hopper
Model	AC-6B18-4C-19	AC-6B24-4C-19	AC-6B30-4A-19
Generation	4.0G Plus	4.0G Plus	4.0G Plus
Weighing Range	15g-500g	15g-500g	15g-500g
Max.speed	200 WPM or 3X60 WPM	240 or 4x60 WPM	300 or 5x60 WPM
Power Supply	220V,50/60HZ,3kW	220V,50/60HZ,4.0kW	220V,50/60HZ,4.5kW
Hopper Volume	0.8L	0.8L	0.8L
Monitor	10.4 inches color touch screen		
Dimension(mm)	2000×1550×1700	1966×1966×1584	2270×2270×2188

## Blending products by 2/3/4/5 products at high speed and high accuracy



Blend 4 kinds of materials



Blend 5 kinds of materials



AC-6B24-4C-19 (24 Heads)

AC-6B30-4A-19 (30 Heads)

# ANTI-STICKY WEIGHER

## Application

Sticky and fresh product, fragile and difficult moving product, like fresh meat, cook rice, vegetable, saucing products, sea food and shell etc.



## Main Features

- Optional linear feeder driven by vibration, screw and conveyor.
- Hoppers with scraper doors to force sticky products down.
- 3-level hoppers including memory hoppers to increase speed and accuracy.
- Automatic feeder can be an option according to materials.

Scraping Plastic Hoppers



## 8 Heads Anti-sticky weigher (Screw Feeder)



## 10 Heads Anti-sticky weigher (Conveyor Feeder)



## Specifications

Item	Anti-Sticky 6-Head Multihead Weigher	Anti-Sticky 8-Head Multihead Weigher	Anti-Sticky 10-Head Multihead Weigher
Model	AC-6B12-2B-22J	AC-6B08-2B-22FA	AC-6B10-4A-22FA
Generation	4.0G Plus	4.0G Plus	4.0G Plus
Weighing Range	15g~1000g	15g~1000g	15g~1000g
Accuracy	±1-10g	±1-10g	±1-10g
Max.speed	40WPM	60WPM	80WPM
Power Supply	220V,50/60HZ,1.5kW	220V,50/60HZ,2.0kW	220V,50/60HZ,2.5kW
Hopper Volume	1.5L(scraping hopper)	1.5L(scraping hopper)	1.5L(scraping hopper)
Monitor	10.4 inches color touch screen		
Dimension(mm)	927×1327×1593	974×1963×1593	974×2281×1506

# SUPER PRECISION MICRO WEIGHER

## Application

Tea/Spices/Herbs/Tablets/  
Capsules/Dried flower/  
Tiny weight products etc



### AC-6B14-4A-36

#### Main Features

- One of the smallest and most precise multihead weighers in the world.
- Ultra-low target weights at high speed and unbelievable accuracy.
- Target weight from 0.5g to 50g at speed up to 120 weighments per minute.
- Weight measures as low as 0.01g, target weights as low as 0.5g, accuracy as low as 0.03g.
- Applied 4.0 generation software advanced technologies, faster and more accurate than ever before, easier to clean and simpler to operate.

Super Precision  $\pm 0.03g$



## Specifications

Item	Micro 14 Heads Weigher
Model	AC-6B14-4A-36
Generation	4.0G Plus
Weighing Range	0.5g-50g
Accuracy	$\pm 0.03g$
Max.speed	120WPM
Power Supply	Single phase, 220V, 50/60HZ, 2kW
Hopper Volume	0.1L
Monitor	10.4 inches color touch screen
Dimension(mm)	942*942*1399

# MANUAL WEIGHER

## Application

Potato, biscuits, seafood, meat,  
and other fragile products.

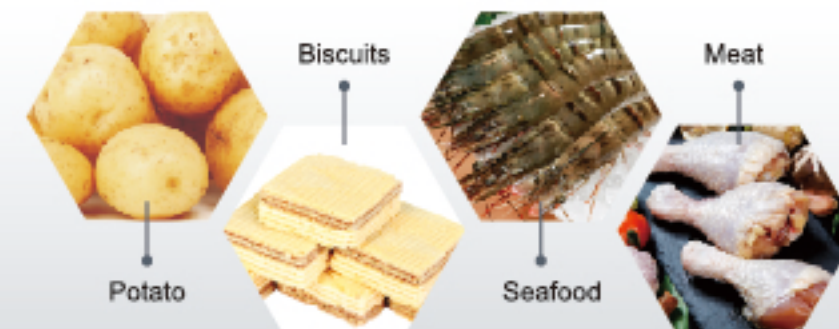

### AC-6B12-2B-S01

#### Main Features

- Possible to achieve max. combination speed of 30 packs/min.
- Interfacing to packaging machines is easily done.
- Adoption of belt-conveyor system for discharge.
- Reduction in washing time at the end of work and at the change-over of weighing products.
- All conveyor belts are easily detachable.

Space Saving Design



## Specifications

Item	12 Heads Manual Multihead Weigher
Model	AC-6B12-2B-S01
Generation	4.0G
Weighing Range	15g-3000g
Noice Level	$\pm 1g$
Max.speed	50WPM
Power Supply	220V, 50/60HZ, 1.5kW
Working Humidity	35%-85%
Working Temperature	-10°C-40°C
Monitor	10.4 inches color touch screen

# SCREW FEEDER WEIGHER

## Application

Pickled foods: such as tuber mustard, spicy fish, sour bamboo shoot, Chinese sauerkraut



## AC-6B20-4A-47F(20 Heads)

### Main Features

- Adopting patent connecting rod, compared with gear drive, it can more effectively prevent jamming and dirt, and ensure stable running.
- Special plastic scrapers make the material fall smoothly.
- Anti-condensation device makes it possible to weigh accurately even in humid, cold and other complex environments.
- Powerful networking function and camera to facilitate real-time monitoring of production conditions.

Pickles Multihead Weighing



## Specifications

Item	Screw Feeder Weigher		
Model	AC-6B14-4A-47F(14-Head)	AC-6B16-4A-47F(16-Head)	AC-6B20-2B-47F(20-Head)
Generation	4.0G Plus	4.0G Plus	4.0G Plus
Weighing Range	15g~500g	15g~500g	15g~500g
Accuracy	±1g	±1g	±1g
Power Supply	220V,50/60HZ,2.8KW	220V,50/60HZ,3KW	220V,50/60HZ,3.5KW
Hopper Volume	1.3L	1.3L	1.3L
Monitor	10.4 inches color touch screen		
Dimension(mm)	1450*1450*2375	1380*1380*2330	1450*1450*2380

# STICK-SHAPE WEIGHER

## Application

Sausages, biscuits, chopsticks, toothpicks, steel nails and other strip materials



## AC-6B14-4A-11F

### Main Features

- Reversible motor on vibrator helps the dropping of sticks from top cone to linefeeder pan more effectively.
- Special V shape linear feeder pan collects the sticks at the center and drop vertically to the feed bucket.
- Round tube device added to the bucket center to make sure the sticks drop vertically from feed bucket to weigh bucket.
- U-shape independent chute design helps discharge strip products vertically to the packing machine.

Stick-Shape Multihead Weigher



## Specifications

Item	3L Stick-shape 14 Heads Multihead Weigher
Model	AC-6B14-4A-11F
Generation	4.0G Plus
Weighing Range	15g~3000g
Accuracy	±5g
Max.speed	80WPM
Power Supply	220V,50/60HZ,2.5KW
Hopper Volume	3L
Monitor	10.4 inches color touch screen

# ANTI-DUST WEIGHER

## Application

Small granules, dusty product, flowing powder, mixed product like: rice, seeds, sugar, salt, seasoner, detergent, desiccant, cereal etc.



## AC-6B10-2B-16M(10 Heads)

### Main Features

- Complete machine sealed with visual cover to avoid raising dust.
- Big round corner design on all hoppers and discharge chutes, plain contact parts.
- Option with teflon or ceramic coated.

Sugar / Detergent weigher



## Specifications

Item	Powdery Weigher / Anti-dust Weigher
Model	AC-6B10-2B-16M(10-Head)
Generation	4.0G
Weighing Range	15g~1000g
Accuracy	±1g~5g
Max.speed	60WPM
Power Supply	220V,50/60HZ,2KW
Hopper Volume	2L
Monitor	10.4 inches color touch screen
Dimension(mm)	1150*1420*1840

## Options & Modifications



Infeed tower



Independent linear feeder pan



Buffer tube for stick



Anti rotation material guider

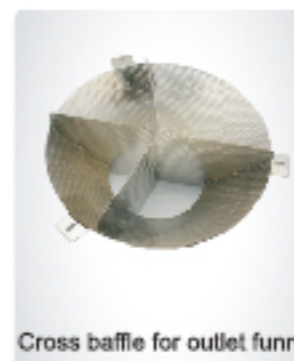

Cross baffle for outlet funnel



Pressure valve



Special top cone for stick



V shape linear feeder pan



Diverter tube



Collection bucket



Foot paddle switch



Leak-proof pad

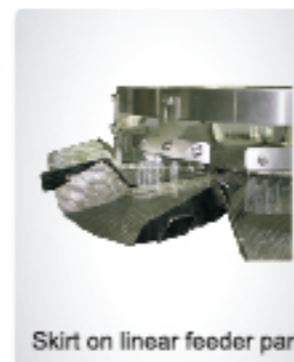

Skirt on linear feeder pan

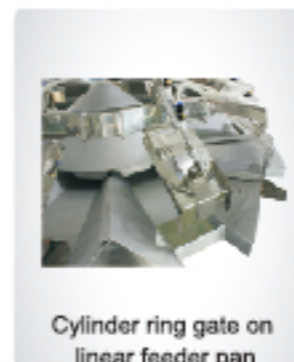

Cylinder ring gate on linear feeder pan



Buffer plastic board



Teflon coated hopper

- Weighing speed and accuracy may change depending on different product characteristics.
- For more models, please consult the sales; special machine parts can be customized.
- Reserve the right to change the parameters without prior notice.

# POTATO WEIGHER

## Application

Potato, orange, carrot, onion, full range farm products

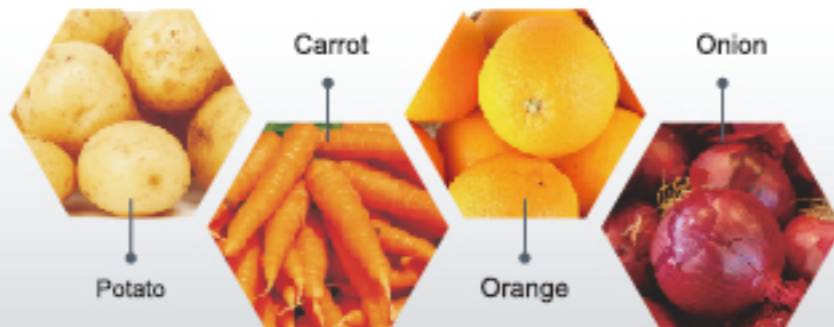

## AC-6B20-2B-40F

### Main Features

- Best combination of linear and multihead weigher technology, most suitable machine for farm products.
- Stronger feeders to dispense heavy products. Program refers to product photo, and max 99 programs stored.
- Much higher speed performance than the traditional linear weigher.
- Gentle handling to farm product by patent hoppers and soft belt conveyor.

Special linear & combination scale



## Specifications

Item	Potato linear 10-Head Multihead Weigher	Potato linear 20-Head Multihead Weigher
Model	AC-6B10-4A-29FA	AC-6B20-2B-40F
Generation	4.0G Plus	4.0G Plus
Weighing Range	100g-4000g	50g-5000g
Accuracy	±5g-20g	±5g-20g
Max.speed	60WPM	120WPM
Power Supply	380V,50/60HZ,2.0kW	380V,50/60HZ,5.0kW
Hopper Volume	5L	2L
Monitor	10.4 inches color touch screen	10.4 inches color touch screen

# ANTI-FRAGILE WEIGHER

## Application

Prawn crackers, biscuits, chocolate, frozen materials and other fragile materials

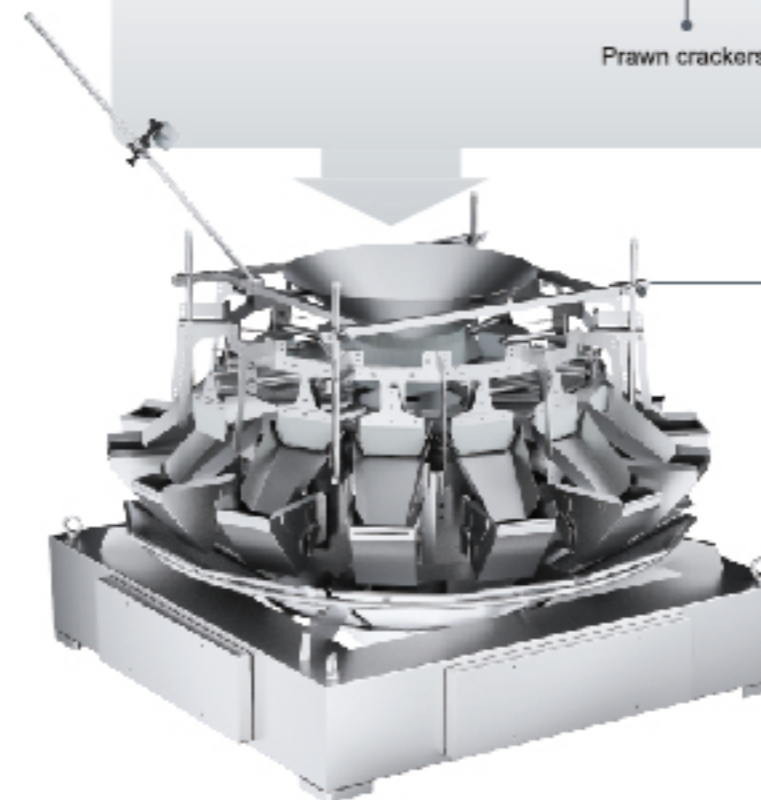
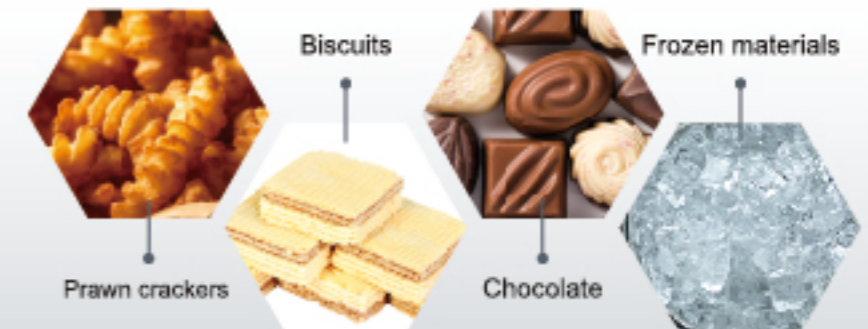

## AC-6B14-4A-35F

### Main Features

- Gentle handling design for fragile products.
- One of the lowest drop height multihead weighers in industry.
- Reduce breakage and improve protection on products.
- Using soft pad hoppers and shallow flow discharge chute.
- Latest technology with modular control and easy operate touch screen.

High Dream New Design



## Specifications

Item	14 Heads Anti-fragile Multihead Weigher
Model	AC-6B14-4A-35F
Generation	4.0G Plus
Weighing Range	15g-3000g
Accuracy	±1g
Max.speed	60WPM
Power Supply	220V, 50/60HZ, 2kW
Hopper Volume	3L
Monitor	10.4 inches color touch screen